

● 2026

Benchtop CO₂ systems

SFXBT1L-2A Specification©



Benchtop CO₂ systems

2

The SFX Benchtop Series offers an excellent entry point into supercritical CO₂ technology, combining user-friendly operation with a compact and versatile design for small-scale process development.

Intended for both research and educational use, it provides a practical platform for training new users in the principles of clean and sustainable CO₂ processing. Despite its small footprint, the system incorporates many of the advanced features found on larger-scale units, enabling detailed investigation of key process parameters across a range of applications including extraction, reaction, drying, cleaning, and sterilisation. Each system can be configured with either manual controls for cost-effective experimentation or fully automated operation for high precision, repeatability, and advanced research capability.



Systems

- SFXBTD50mL
- SFXBT100mL
- SFXBT500mL
- **SFXBT1L**



CS200-1

SN# 2015637-2
KIT# E20036

What is CO₂ Processing

Most people are familiar with CO₂ presenting as three states of matter: solid, liquid and gas. These states are dependent on the temperature and pressure of the CO₂. In its natural state, CO₂ is most abundant as a gas making up around 0.04 % of the earth's atmosphere. However, by altering the ambient conditions we can transform CO₂ into either a liquid or a solid.

A phase diagram can be used to determine the state at which CO₂ exists at both a defined temperature and pressure (see figure 1-1). For CO₂ we see two intersect points on the phase diagram, the triple point and the critical point.

The triple point is where the three states of matter (solid, liquid and gas) co-exist in equilibrium. For CO₂ the triple point is 5.1 bar and -56 °C. Any change from these conditions alters the state of matter in favour of one of these forms.

For example, CO₂ as a liquid exists when the pressure exceeds 5.2 bar at temperatures between -56 °C and 31 °C (these are the temperatures falling between the triple and the critical point - See figure 1-1).



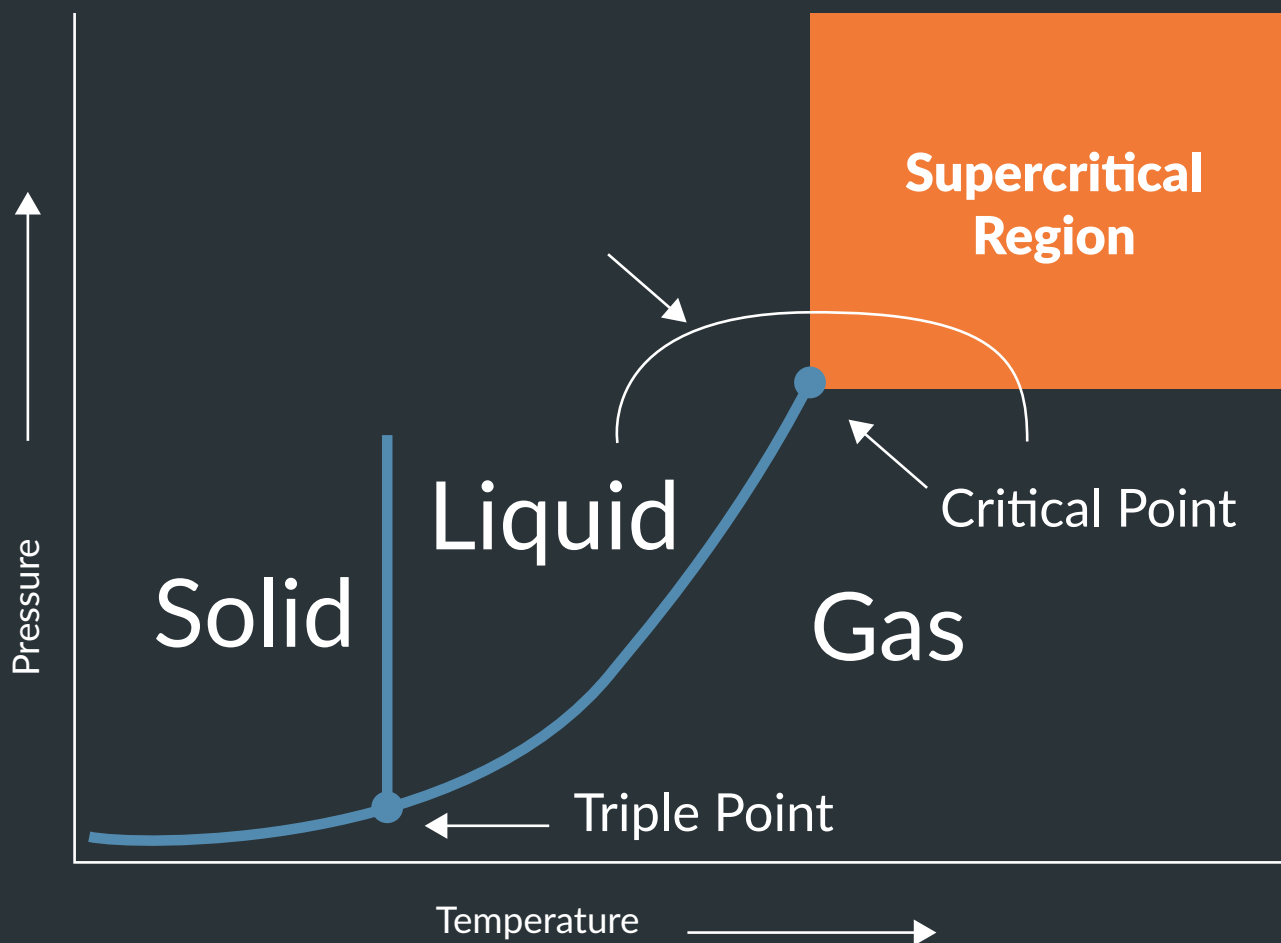

Figure 1-1: Supercritical CO₂ is tuneable without changing phases

Why use Supercritical CO₂

Supercritical Fluid Extraction (SFE) using CO₂ is commonly used to extract compounds from solid botanical materials due to its achievable pressure and low temperature (critical temperature and pressure of 31 °C and 74 bar). It exhibits a number of benefits unique to CO₂ over traditional petrochemical derived alternatives.

Tuneable Density - Supercritical CO₂ occurs when CO₂ is compressed to 74bar @ 31 ° C. This results in a density of around 440 kg/m³. However, as the pressure and temperature alter the density can increase to over 1000kg/m³ (density of water). This tuneable density gives CO₂ its selective extraction properties and makes it a very versatile solvent.

Tuneable Polarity - CO₂ is a good extraction solvent for lipophilic and hydrophobic molecules, which is why it is popular in natural product extraction. However, there are times when the product of interest is more polar. The polarity of the CO₂ can be adjusted with the addition of a solvent of higher polarity such as ethanol. Small percentages of more polar solvents can have a significant effect on which components are extracted. It can also help reduce the pressures required to extract components such as polyphenols.

Selective Fractionation - During an extraction, conditions can be adjusted to alter the density of the CO₂ to selectively extract specific components. The same tunability is possible on the collection side.

With a system that has multiple collectors with their own back pressure regulators, the conditions in each separator can be adjusted to achieve a specific density. Selectively precipitating different compounds into each of the separators.

Isolation - When isolating the extract from a CO₂ extraction, it requires depressurisation of the CO₂. This involves a phase change from a supercritical fluid into a gas. This ultimate change in density results in the separation of the dissolved compounds from the CO₂. The CO₂ gas is then able to escape leaving the extract uncontaminated by the extracting fluid.

Recyclable - One of the most powerful aspects of CO₂ as a solvent is witnessed when collecting the product from the separator as it reverts to a gas, so leaving your product uncontaminated. We can also re-use the CO₂ by re-compressing it. The most common method is to drop the pressure of the CO₂ in the final collector to 55 bar (bottle pressure) so that it can be recycled back into a storage tank for reuse.

However, this can present some challenges, as materials can carry over and cause blockages. The material that is carried over can also contaminate the extraction process. By understanding the material and process conditions, these effects can be minimised and/or removed.



Environmentally Responsible - Unlike other solvent extraction, CO₂ is recovered from other industrial processes as a by-product. It is purified and stored ready for use in many different processes including supercritical CO₂ extractions. The renewable and abundant nature of CO₂ is one of the most attractive properties when using CO₂ as an alternative solvent, however it also has other benefits:

1. Non-toxic,
2. Non-flammable
3. Non-Eco toxic

This combination of properties makes CO₂ a powerful alternative solvent for industrial processing.

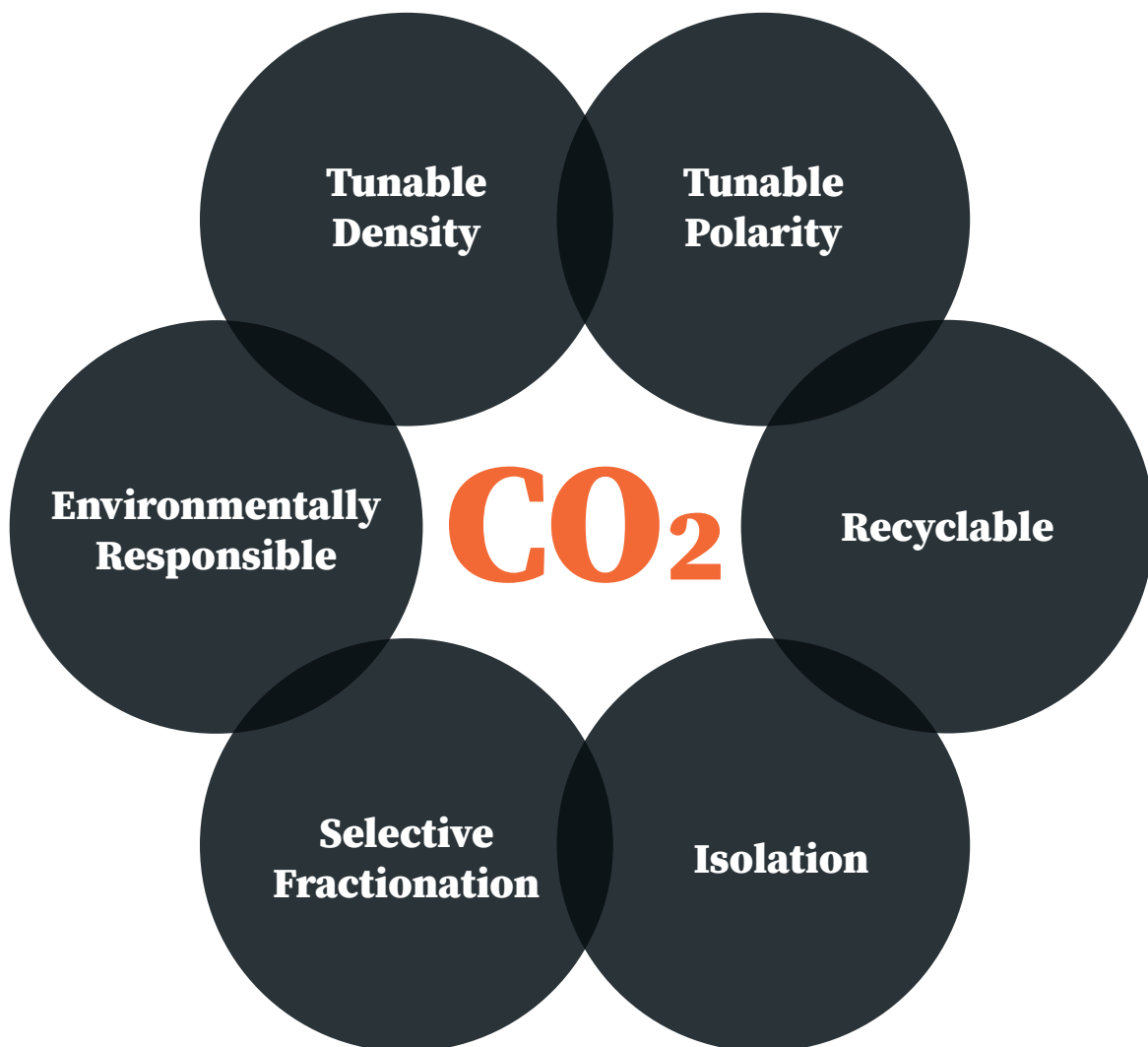

System Styles

1 Standard Systems

Standard supercritical systems operate at pressures up to 350 bar or 689 bar, depending on the configuration. The vessels are electrically heated using barrel heaters and are rated for operation between 25 °C (ambient) and 150 °C. To generate a supercritical fluid, the system must operate above 74 bar and 31 °C. However, supercritical fluids are highly tuneable, their density, viscosity, and solvating power can be adjusted by varying either the pressure or temperature within the system. While these systems can also function in the subcritical range, precise temperature control between 25 °C and 31 °C is limited.

2 Subcritical CO₂ Systems

Subcritical CO₂ systems operate at reduced temperatures below the critical point of 31 °C, while still under elevated pressure. Although subcritical conditions can be defined by both temperature and pressure, most systems are configured with liquid cooling and heating, enabling operation at sub-ambient temperatures. To achieve this, a separate recirculating heater-chiller is required and a liquid jacket must be fitted to the extraction vessel, making these systems more expensive to build and operate.

These additional requirements give subcritical systems a broader operational window, allowing users to fine-tune parameters for compounds that are heat-sensitive or require milder extraction environments. For example, subcritical CO₂ delivers a colder solvent stream, which in many extractions avoids the co-extraction of long-chain waxes that can complicate compound isolation in post-processing. By broadening the range of achievable states, subcritical CO₂ enhances overall flexibility, making it well-suited to a wider variety of processes and materials.



Comparison of CO₂ Extraction Systems

Feature / System	Subcritical CO ₂	Supercritical CO ₂	Ultra-High-Pressure Supercritical CO ₂
Operating Conditions	Below 31 °C, elevated pressure (liquid phase)	Above 31 °C and 74 bar, typically up to 700 bar	Above 31 °C, extended to ~1000 bar
Extraction Selectivity	Gentle conditions, avoids waxes and protects heat-sensitive compounds	Wide compound range from non-polar to moderately polar	Access to compounds locked in tough cell walls (e.g. microalgae)
Typical Applications	Heat-sensitive botanicals, flavours, delicate natural products	General natural product extraction, food, pharma, materials	Microalgae, hard-to-extract biomaterials, advanced pharma
Advantages	Broader operational window, improved selectivity for delicate compounds	Balanced flexibility and efficiency	Unlocks high-value intracellular compounds otherwise unrecoverable

Process Flow Diagram

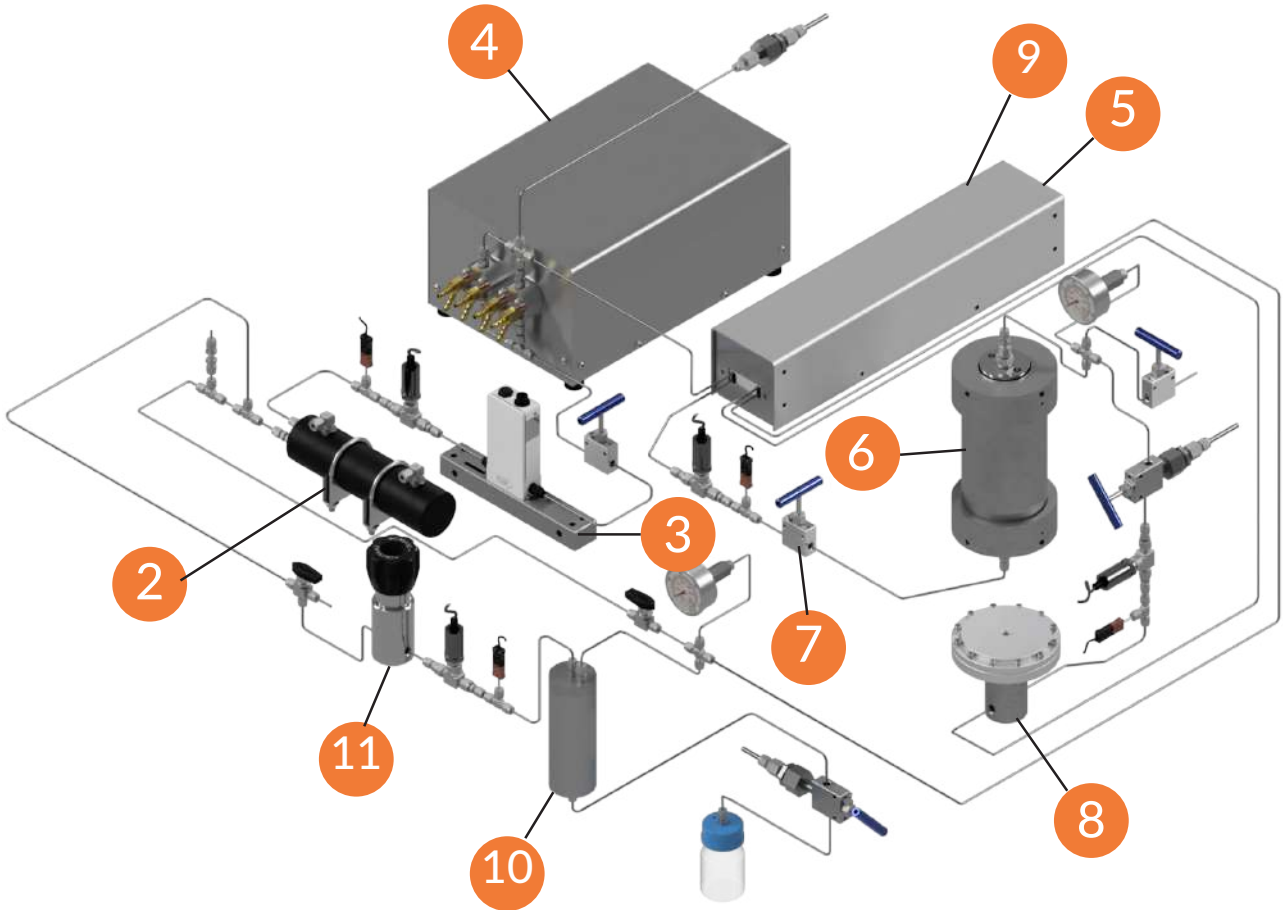

1 CO2 Cylinder

2 Condenser

3 Flow Meter

4 CO2 Pump

5 Pre-Heater

6 Extraction Vessel

7 Inlet and Outlet Valves

8 Back Pressure Regulator

9 Vaporiser

10 Separator

11 MBPR

1

**Core | CO₂ Cylinder****(included)**

CO₂ systems start with a source of liquid CO₂ produced as a by-product from other industrial processes. The CO₂ is delivered as a liquid and not a gas as the high-pressure pumps are designed to compress liquid into its supercritical state.

2

**Core | Condenser****(included)**

Although we use a liquid CO₂ feed in our extraction systems, it's important that the incoming CO₂ remains liquid. The condenser acts to maintain the incoming temperature of the CO₂ ensuring it remains a liquid during the pumping phase. Additional condensers can be added with higher flow rate pumps or the addition of a recycling unit.

3

**Core | Flow Meter****(optional)**

Using a mass flow meter corrects the speed of the pump as the density varies, allowing us to accurately deliver the correct mass of CO₂ during an extraction. We can observe the in-coming CO₂ densities in real time into the system which helps us quickly diagnose any problems with the incoming CO₂ supply.

4

**Core | CO₂ Pump****(included)**

The pump is designed for minimal pulsation using two pistons for an operating pressure range of up to 689 bar. Pump heads are cooled for efficient operation by removing compression heat, using circulating chilled fluid via cooling tubes inserted into machined cavities in the pump head.

5

**Core | Pre-Heater****(included)**

The pre-heater is located just after the pump to control the temperature of the CO₂ reaching the extractor. It ensures the CO₂ entering the extraction vessel is already at the optimum extraction temperature ensuring a controlled extraction process.

6

**Core | Extraction Vessels****(included)**

The double-ended vessel comes with threaded closures for easy, fast and safe opening. Its sealing design allows for hand-tight operation for the end caps that are also fitted with frits to retain feedstock. The vessel is electrically heated with a heat jacket and thermocouple for temperature control.

7

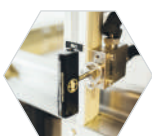
**Core | Inlet and Outlet Valves****(included)**

Inlet and Outlet valves - These valves allow the entry and exit of CO₂ into the extraction vessels.

8

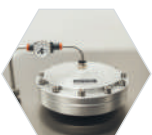
**Core | Automatic Back Pressure Regulator (ABPR)****(included)**

The pneumatically actuated diaphragm acts on the needle assembly within the regulator to automatically regulate the extraction pressure in the system.

9

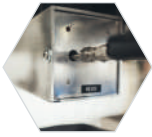
**Core | Vaporiser****(included)**

The Joule-Thomson effect is observed when we go from a high pressure to a low pressure resulting in a drop in temperature. To overcome this, we use a Vaporiser to heat the CO₂ exiting the ABPR. The vaporiser also helps to expand the CO₂ from its liquid state into a gas in-order to help precipitate the extracted components.

10

**Core | Separator****(1 included)**

The mixture leaving the extractor, composed of extract/CO₂ and solvent, is depressurised in one or more separators. At each pressure stage, the extract is separated from the CO₂ at the desired pressure, before the CO₂ is recycled or vented after the last separator.

11

**Core | MBPR****(1 included)**

By modifying the pressure and temperature in each separator the density can be accurately controlled to favour the precipitation of some components over others. The manual back pressure regulators facilitate the control of the pressure in each of the separators.

High-Pressure CO₂ Pump

This pump has been purpose-built for rugged operation in production environments, using a proven gearbox and motor drive with custom-engineered check valves to ensure efficient, reliable CO₂ compression. Rated to 1100 bar (1000 bar operating), it provides the strength and safety demanded in continuous industrial use.

The system operates in two modes:

Flow Mode - when paired with a flow meter and closed-loop control, it delivers highly accurate and repeatable flow rates.

Pressure Mode - capable of applying precise pressure directly to a vessel.

While robust enough for full-scale production, its flexible dual-mode operation and precision control also make it ideally suited to research environments, where process development and optimisation require accuracy, repeatability, and scalability.

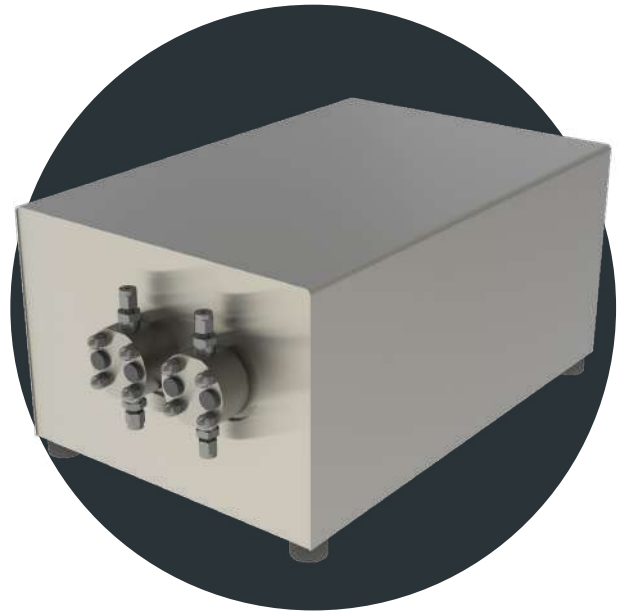

Minimum Flow - **1g/min**

Maximum Flow - **15 g/min**

Find your perfect Pump online

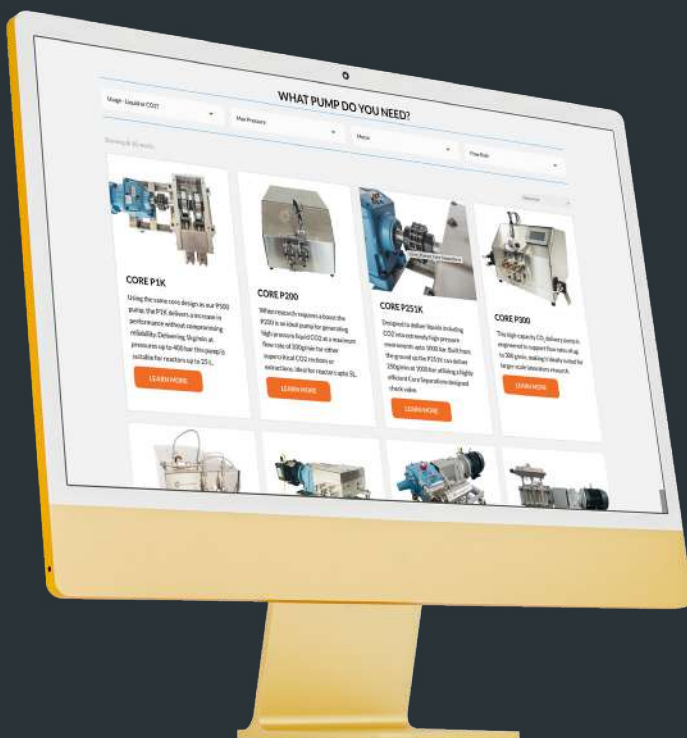

Need a compact laboratory CO₂ pump or a high flow rate industrial pump? Why not visit our website and use our easy filter to pick the perfect pump!

[Visit the filter](#)



Continuous vs Batch

Pressure Mode vs. Flow Mode

Supercritical CO₂ systems support a wide range of applications—from extraction and reaction to particle formation, sterilisation, and cleaning. While many systems on the market are optimised for extraction and continuous flow, certain processes benefit more from batch operation, where precise pressure control is essential. Examples include sterilisation, soaking steps in extraction, or hydrolysis with subcritical water, where maintaining liquid-state stability requires sustained pressure independent of temperature.

Core Separations systems provide both Flow Mode and Pressure Mode operation, offering flexibility to suit a variety of processes.

Flow Mode

In flow mode, the pump delivers CO₂ (or water) to the reactor while pressure is controlled by the ABPR in conjunction with Adaptive Pressure Control (APC). A flow meter can also be integrated, enabling closed-loop operation for precise and repeatable flow control. Flow and pressure act independently, allowing users to fine-tune flow rates while the ABPR automatically regulates back pressure for stable, accurate operation.

Pressure Mode – Batch Processing

In pressure mode, the ABPR is bypassed and the pump itself generates and maintains pressure, typically against a closed valve. The pump uses a controlled PID loop to gradually slow as it approaches the setpoint, eliminating the pulsation issues associated with traditional pressure switch methods. This enables accurate pressurisation and stable setpoint maintenance, making it ideal for batch-based applications.

With both modes available, users can seamlessly adapt the system to the specific requirements of their process—whether continuous flow or precise batch control.

PED Compliant High-Pressure Vessel

The EV1L is a high-pressure extraction and reaction vessel designed for safe operation, easy maintenance, and dependable performance, with a maximum design pressure of 689 bar and recommended operating conditions of 600 bar and 150 °C. Its threaded cap, energised sprung seal, and dual-access head allow tool-free cleaning from either end while reducing seal wear and extending service life.

Manufactured from 17-4PH stainless steel, significantly stronger than conventional 300-series grades, the vessel achieves lighter construction, thinner walls, and improved heat transfer efficiency. The scalable internal geometry enables straightforward transition from laboratory experiments to pilot-scale processing.

With a 1 L capacity, the EV1L is suited to research, development, sample preparation, and process optimisation across a wide range of applications.

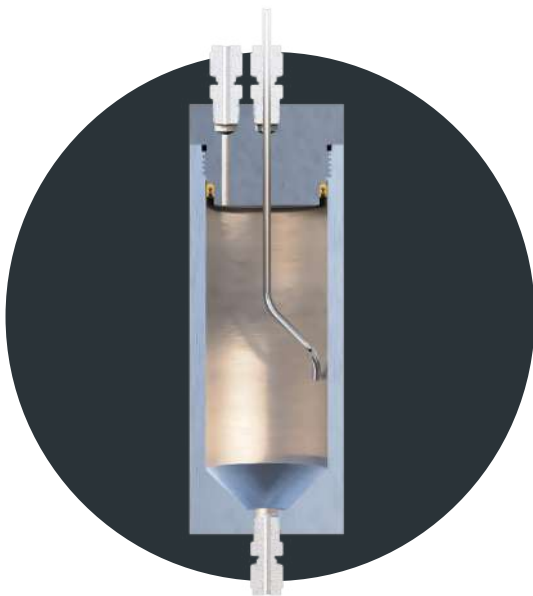
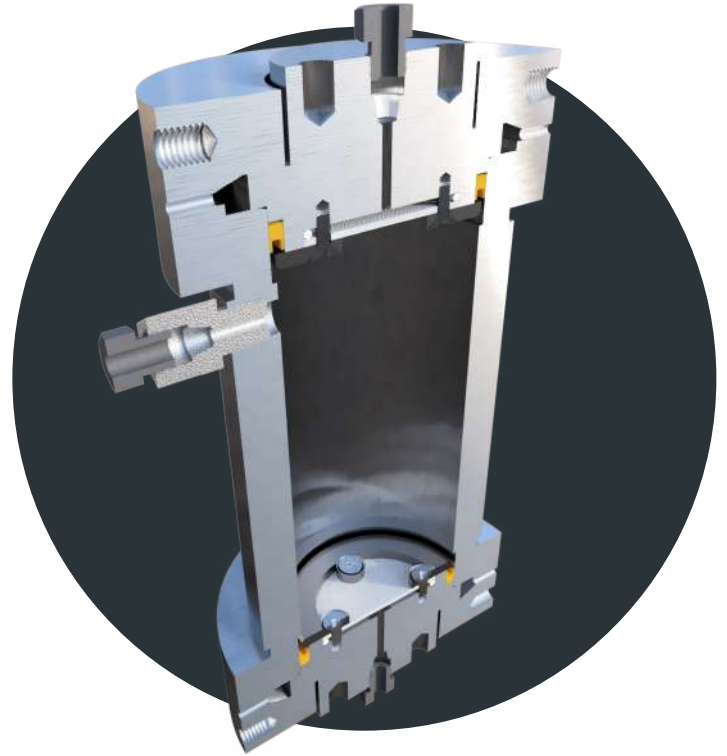

Separator Vessel

This separator vessel is designed for performance and ease of use, with a 200 bar design rating (170 bar operating) and temperature capability up to 100 °C. It promotes the controlled vaporisation of CO₂ into its gaseous form, enabling efficient collection of extracted products.

A tool-less, double-ended design allows fast assembly and straightforward cleaning, reducing downtime between runs. Independent pressure and temperature control supports precise product fractionation, giving operators the flexibility to separate compounds with accuracy and repeatability.

Well-suited to research and development applications, the vessel delivers reliability and control for a wide range of CO₂ processes.

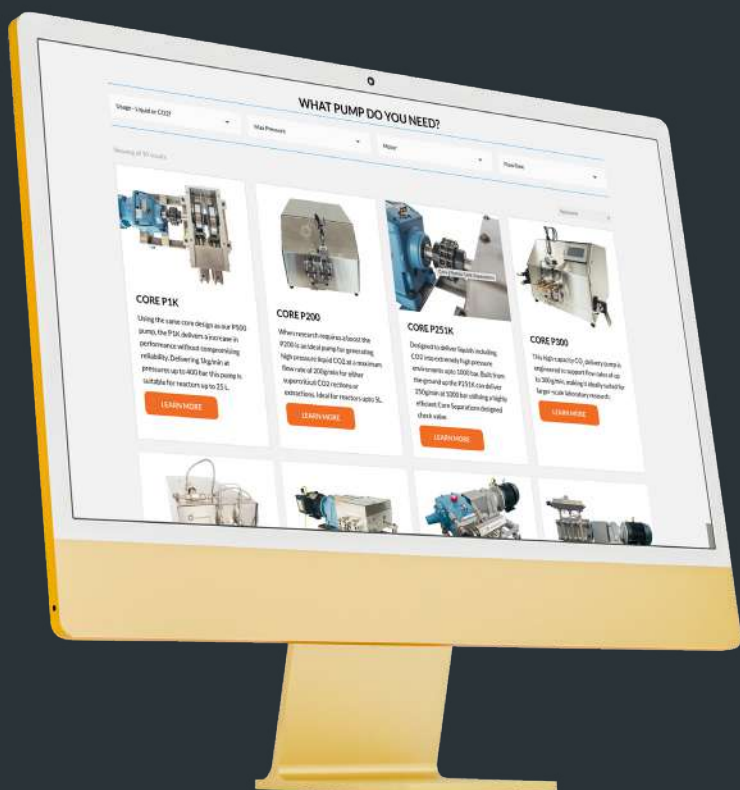

Find your perfect Vessel online

Core Separations CO₂ Pressure Vessels are high pressure, high performance extraction and reaction vessels designed specifically for processing supercritical fluids. Why not visit our website and use our easy filter to pick the perfect one for your needs!

[Visit the filter](#)

CO₂ Recycling Approaches

Closed Loop Recycling

In a closed loop recycling setup, the CO₂ exiting the final collector is diverted directly back into the condenser and then reintroduced to the pump. This approach reduces CO₂ consumption during operation, as the gas is continually recycled through the process rather than being immediately vented. It is normally a lower cost option, as no secondary storage tank or chiller-condenser combination is required for operation. However, the CO₂ is not retained in the system after shutdown, meaning it must be replenished for each new run. Another limitation is the lack of expansion space, which means that if process conditions are not held at steady state, the risk of over-pressurisation increases. Careful monitoring and precise control are therefore essential.

Pump and Storage Tank Recycling

In contrast, storage tank recycling directs the CO₂ into a separate storage vessel at the end of the process. The tank provides expansion space, significantly reducing the risk of overpressure events. More importantly, the CO₂ is retained between runs, allowing for much higher recovery rates, often up to 90% of the CO₂ used in a cycle. The exact recovery efficiency depends on user practice and system management. This method not only lowers operating costs but also reduces the environmental footprint of CO₂ based processing.

Closed loop recycling therefore offers simplicity and low cost, while storage tank recycling provides higher recovery rates and greater long-term efficiency.

Comparison of Recycling Approaches

Feature	Closed Loop Recycling	Pump and Storage Tank Recycling
CO ₂ Retention	Not retained after shutdown	Retained between runs
Recovery Rate	Limited	Up to 90%
Expansion Space	None, steady state required	Built-in expansion space
Risk of Over-pressurisation	Higher if conditions fluctuate	Lower due to storage tank capacity
Cost	Lower, no secondary tank or chiller required	Higher, requires tank and condenser system
Efficiency Over Time	Reduces consumption during operation only	Long-term efficiency with retained CO ₂



Watch on
YouTube

SFX Software

Whether you are in a demanding research environment or within a highly regulated cGMP manufacturing facility, our SFX software has been designed from the ground up, to be both a flexible and powerful companion in processing supercritical fluids.

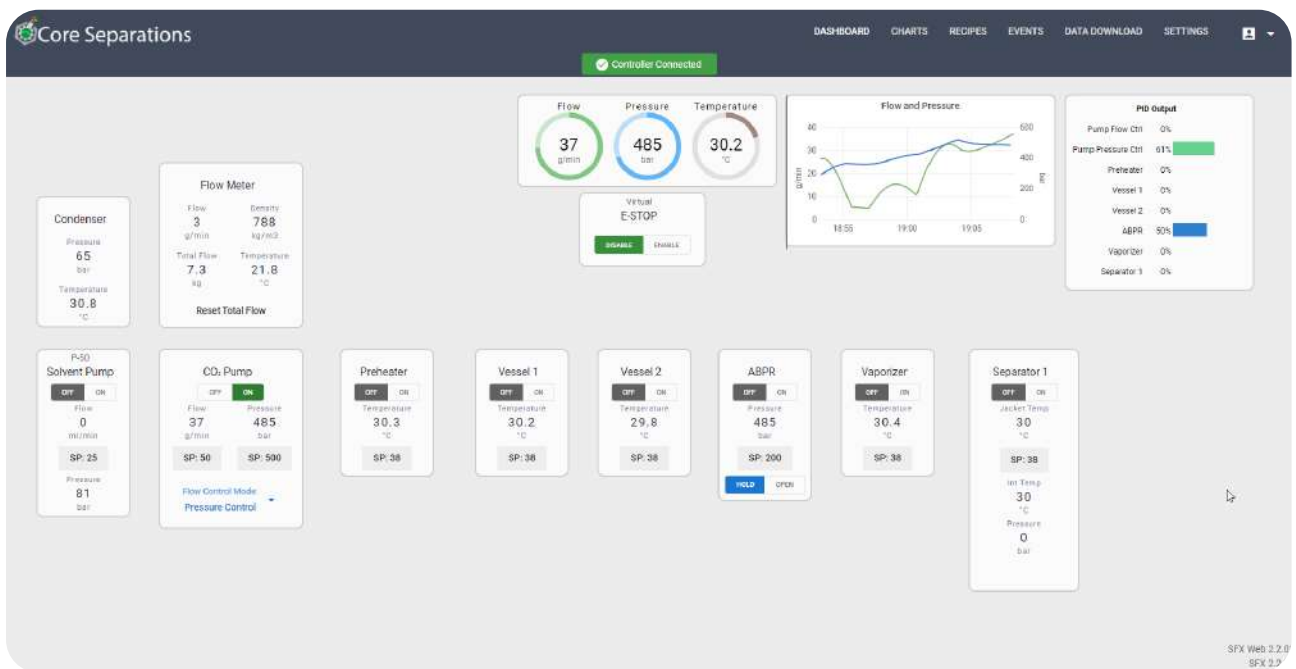

Key Features



Dashboard visualisation of key processing parameters



Manual control of key components within the SFX system in real time using APC to accurately control the pressure



Recipe menu allows you to automate a variety of conditions including flow rates, temperatures and pressures over a defined time limit.



Real time data logging and visualisation via Grafana Dashboard



Programmable warning and alarm limits to alert the user that the system conditions are approaching the cut off safety limits.



SQL database logs all the alarms and user activity to aid in fault detection and diagnosis.

Key Features



Precise pressure management is one of the biggest challenges in supercritical CO₂ systems. Compressing liquid CO₂ up to its critical point of 74 bar occurs at a slower rate than in the supercritical phase, making conventional PID loops prone to large errors and overshoots during pressurisation.

Core Separations' Adaptive Pressure Control (APC) overcomes this by combining advanced algorithms and methods to improve accuracy in both pressurisation and depressurisation.

Key elements include:

- Ramp Rate – integrates a ramp function to minimise error between the setpoint and process value. This prevents overshoot, enables faster stabilisation, and can be customised to user requirements.
- Compression Zone – PID calculations are paused during initial pressurisation until a defined setpoint is reached, then automatically re-engaged for stable supercritical operation. Users can configure the compression zone and initiate PID outputs, giving flexibility across processes.
- Accurate Depressurisation – the ramp rate function is also applied to decompression, ensuring controlled pressure release. In processes such as aerogel formation, this avoids the need to manually calculate BPR needle retraction rates, simplifying operation while maintaining precision.

APC is one of the most advanced pressure control systems available, delivering stable, accurate, and automated CO₂ pressurisation and depressurisation.



SFX Software

SFX is a powerful control platform designed specifically for CO₂ systems, providing both precision and adaptability across a wide range of operating conditions. Built on a robust SQL database, it continuously records process data in real time, ensuring that no detail is ever missed.

The modular architecture allows users to tailor functionality to their needs, combining ease of use with advanced process control. Key modules include:

- Dashboard – clear overview of all key process variables
- Real-Time Data Collection – enhanced with a Grafana add-on for advanced visualisation
- Recipes – store and repeat process conditions with confidence
- Error Logging – comprehensive fault tracking for reliable operation
- Data Download – easy access to full process history for analysis
- Scripting & Settings Manipulation – advanced customisation and fine control

By integrating these modules, SFX enables operators to run complex CO₂ processes with accuracy, repeatability, and flexibility.



Watch on YouTube



Dashboard Module

The dashboard provides a clear, real-time overview of system performance, displaying all critical data at a glance. Designed for ease of use, it allows direct component control and real-time setpoint manipulation, giving operators full command of process conditions.

A well-structured layout highlights the three main parameters—pressure, temperature, and flow—prominently at the top of the screen for instant reference. Integrated PID outputs support fast system diagnosis, helping users quickly identify and resolve process deviations.

With its intuitive design, the dashboard ensures both clarity and control during CO₂ operations.

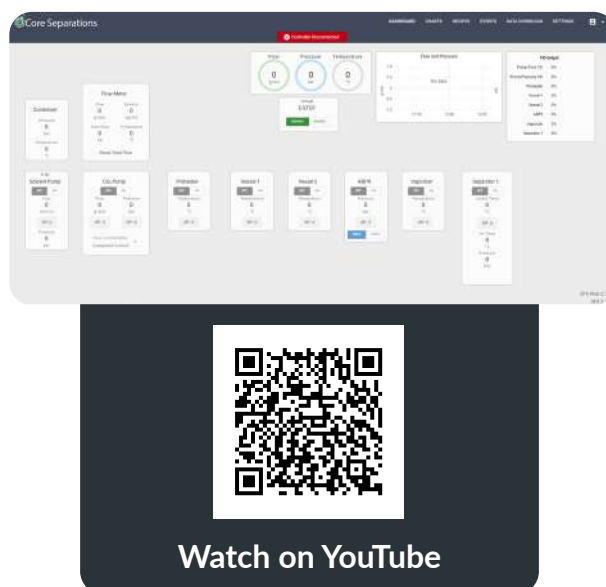

Real-Time Data Module



Powered by the Grafana analysis package, process data is displayed as live plots of flow, pressure, and temperature, giving users an immediate view of system performance. The display is fully customisable to the requirements of the user, with flexible time points and ranges available for real-time analysis.

Any collected data can be plotted to support process optimisation and system diagnosis, providing clear insight into performance and trends during operation.

Recipe Module

The recipe feature within SFX software enables the system to operate much like an analytical setup, using sequence lines to adjust setpoints dynamically over time. This allows users to design detailed routines for pressure, temperature, and flow, tailoring conditions to match specific process requirements.

Each parameter is fully time-controlled, and every component setpoint can be manipulated to build complex recipes. This flexibility makes it possible to automate extraction methodologies for particular natural products, ensuring repeatability, precision, and efficiency across runs.

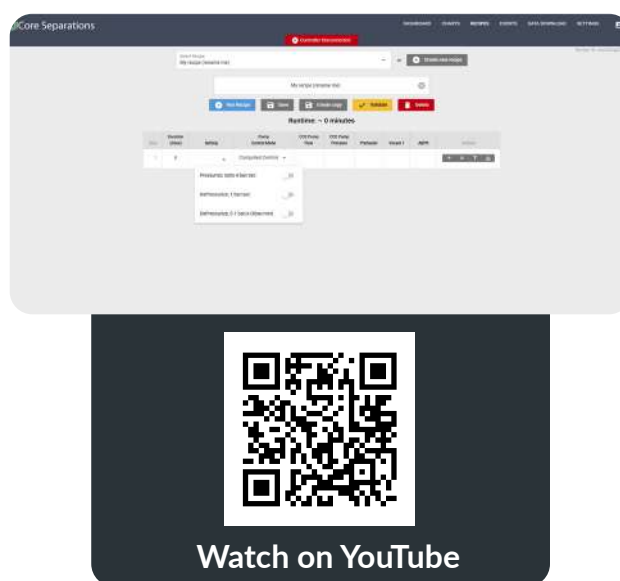

Error Logging Module

Every event, from setpoint changes to alarm triggers, is automatically recorded in the SQL database. This detailed log allows users to trace exactly what adjustments were made and when, while also identifying the specific alarms that led to system shutdowns.

By maintaining a complete event history, the module provides transparency, supports troubleshooting, and ensures reliable system operation.

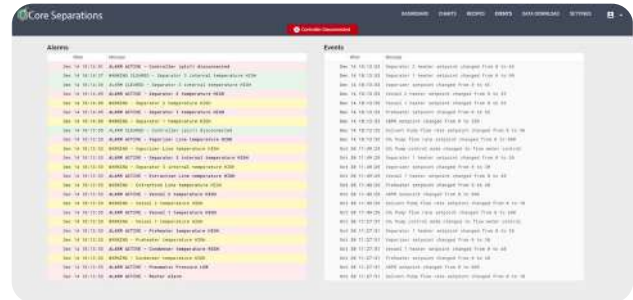

Scripting Module

The scripting module unlocks advanced control features, allowing users to tailor system behaviour to specialised process requirements. For example, certain applications may require PID re-tuning at different stages, and scripts can be created to automatically load these adjustments. Scripts can also be linked into the recipe module, enabling seamless integration of advanced control routines into automated processes.

This module also supports flexible sensor control. In cases where multiple sensors are installed—for instance, a separator with both jacket and gas-phase temperature probes—the user can select which sensor drives system control while the other remains in monitoring mode. This allows operators to shift control between different measurement points (e.g., controlling from the gas temperature while monitoring the jacket), providing adaptability to match the specific demands of a process.

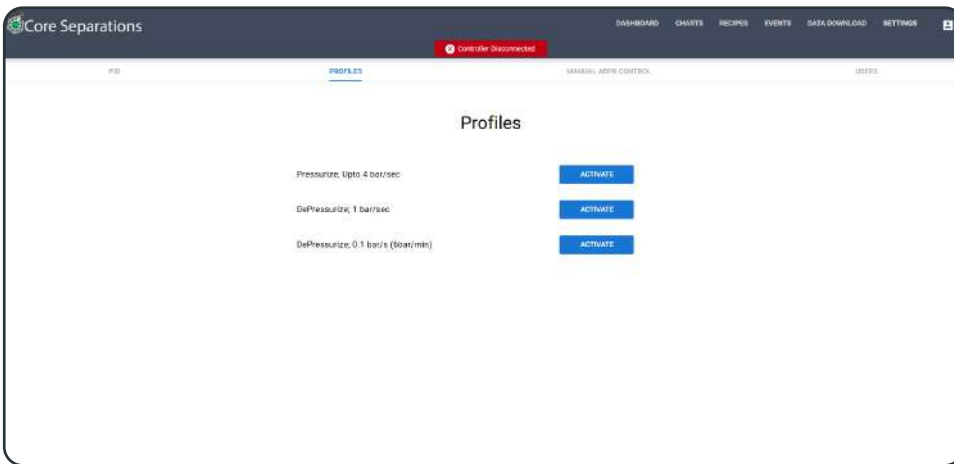

Data Module

System data is continuously recorded, whether the unit is actively running or idle. This ensures users have access to a complete history of data for the entire lifetime of the system.

Collected data can be downloaded in CSV format, either over a defined time range or as a batch linked to a completed recipe run. Once downloaded, data can be plotted as graphs or compared directly with other datasets, supporting in-depth analysis and process optimisation.

Data capture is always active and requires no user intervention—there is no need to start or stop recording.

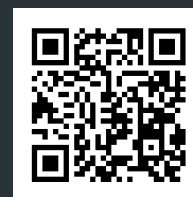
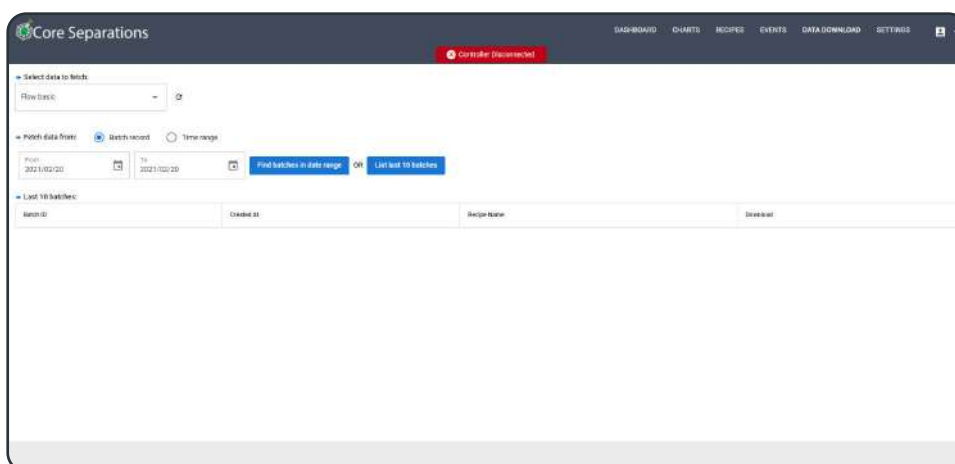

Watch on YouTube

Settings & Control Module

This section provides access to the PID settings for the flow meter, ABPR, and heaters. While the default configurations are suitable for most processes, users can fine-tune these values to achieve more process-specific control. Manual adjustment of the ABPR is also available, typically used for calibrating the I2P controller.

User control functionality is included, allowing permissions to be set and restricting access to specific features based on user roles. This not only enhances safety by reducing the risk of operator error but also supports compliance and traceability across different levels of system use.



Watch on YouTube

Dimensions

Front View

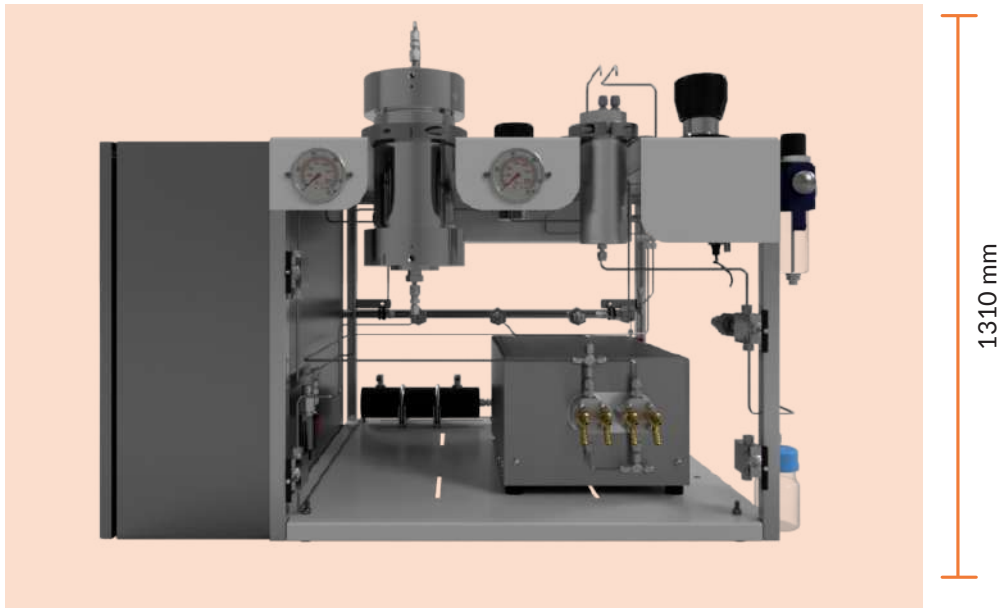

Top View

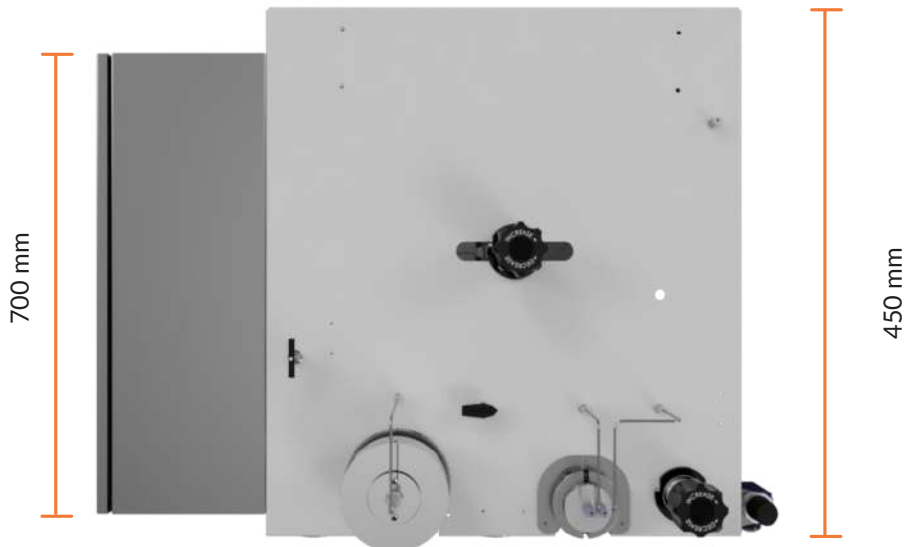

System and component details

Technical Specifications

System's technical specifications	
Extractor volume	500mL
Max operating pressure	600 bar (8700 psi, allowance for relief or safety devices)
Max operating temperature	Up to 150°C
Max operating flow CO ₂	0.9 Kg/hr (15g/min)

Specification and Requirements



Power requirements

220-240 V (Single Phase); 13A



Pneumatic Air Pressure (bar/psi)

6.9 bar / 100 psi, 1/4" compression inlet



CO₂ Inlet

55 bar, 1/4" compression inlet



Vent Line

3/4" compression inlet



Weight

100/150 kg (depending on options)



Chiller

Required



PC & Monitor

Minimum of 1.5 GHz, 16 GB RAM, 250 GB storage, Ethernet port for control panel, wired or wireless connection for Internet connectivity. Google Chrome browser. Monitor 21" minimum with 1920 x 1080 pixels resolution

SFXBT1L

Specification



Condenser

Maximum operating pressure	350 bar (5100 psi)
----------------------------	--------------------

Flow Meter (optional)

Standard flow rate	1 to 20 g/min
Maximum operating pressure	200 bar (2900 psi)

High Pressure CO₂ Pump

Standard flow rate	0.9 Kg/hr (0.9 g/min)
Maximum operating pressure	600 bar (8700 psi, allowance for relief or safety devices)
Maximum design pressure	689 bar (10,000 psi)
Control	Computed Flow Control, Pressure Control, Flow Meter Control (with purchase of Flow Meter Option)

Pre-heater

Maximum operating pressure	689 bar (10,000 psi)
----------------------------	----------------------

Extraction Vessel

Capacity	1L
Max operating pressure	600 bar (8700 psi), design 689 bar
Max operating temperature	150°C
Temperature Control	Electric Heat Jacket and Thermocouple
Design criteria and certifications	ASME Section VIII, Div. 1; European Pressure Equipment Directive (PED - 2014/68/EU). Note: Actual certificate issued by Notified Body for ASME or PED is at additional cost and listed in options.
Hydrostatic Test Pressure	1.5 X design pressure

Automated Back Pressure Regulator

Standard flow rate	3.6 Kg/hr (60 g/min);
Maximum operating pressure	600 bar (8700 psi), design 689 bar
Pressure Control	Pressure Sensor

Vaporiser

Maximum operating pressure	515 bar (7500 psi)
----------------------------	--------------------

Separator

Volume	250 mL
Max operating pressure	180 bar (2610 psi); Design 200 bar
Max operating temperature	70°C
Control	Pressure control using Manual Back Pressure Regulator, Pressure Gauge, Pressure Sensor. Temperature control with electric heat jacket and thermocouple

FAQ on Extraction

One of the more common applications for sub and supercritical CO₂ is the extraction of natural materials. However, CO₂ is a powerful non-polar solvent and can be used to extract a variety of components traditionally extracted using petrochemical derived solvents such as hexane.

CO₂ has been used in a number of industries for decades with the most recognisable applications being the decaffeination of coffee, hop oil extraction, defatting cacao and in more recent years, extraction of cannabis. The process involves CO₂ either as a pressurised liquid or in its supercritical state passing over a solid bed of the material, extracting soluble compounds. These then can be collected by precipitating them once the CO₂ is depressurised to a gas.



What the best way to approach a new extraction in CO₂?

There are many ways to approach an extraction. The best way is to look back into the literature and see if anyone has done it before. If not, is there something close. As natural products vary, conditions that worked for one researcher may not be optimal for another. Now, as CO₂ extraction is a combination of both varying pressure and temperature it's best to look at the density that is achieved when you alter these conditions. Then you are looking at only one variable rather than two.



When do I use a co-solvent?

CO₂ is a relatively non-polar solvent and therefore is good at extracting non-polar compounds. So when it comes to the extraction of more polar compounds then it needs a little help. By mixing a small amount of a more polar solvent such as ethanol, you can significantly improve the polarity of your extraction stream!



How much CO₂ do i need per extraction?

This is a factor of residence time and solubility in CO₂. The residence time is the amount of contact the CO₂ has with the compounds you are trying to dissolve. For example, if you know how much CO₂ is required to dissolve 1 g of your substrate you can calculate the amount of CO₂ required for your extraction.

250g of CO₂ for 1g of substrate. If you have 250g of substrate then you need $250g \times 250g = 62.5$ kg of CO₂.

”” **So the faster I flow the CO₂ into my vessel the faster the extraction is done?**

Now it starts to get technical! The velocity of the CO₂ in your extractor can begin to cause issues in your extraction. If the velocity is too high you can get channelling in the material. These channels allow the CO₂ to pass through the material without interacting with it. Residence time of the CO₂ is also important. If the velocity is too high, then the CO₂ doesn't have time to dissolve the compounds you are interested in.

”” **So if channeling affects you extraction, does that mean i need to pack my vessel well?**

That's right, if the vessel is half empty then the material floats inside the extractor. The CO₂ can then pass by the material without interacting with it. In reality it will still dissolve some material, but the extraction won't be very efficient.

”” **What is the difference between Subcritical CO₂ and Supercritical CO₂ Extraction?**

The main difference is that in supercritical systems the CO₂ is above the critical point and in subcritical systems is below the critical point. In practical terms a supercritical system operates above 31C and 74 bar with the temperature being the key factor. In most laboratory scale supercritical systems, heating is done electrically. But if you want to go subcritical, in general you are working at temperatures below 31C. This would be limited when using electrical heating. So most subcritical systems use liquids to heat and cool.

”” **But why use subcritical conditions? Isn't Supercritical CO₂ better?**

As with most things it depends. When doing an extraction there are a number of things to consider. Firstly, when we compress CO₂, we increase its density by forcing the CO₂ molecules closer together. By manipulating this density, we can affect what dissolves in the CO₂. But this is not the whole story.... in liquid extractions the biggest driver is polarity. We vary the solvents to alter the polarity. Different polarities give rise to different solubilities in certain compounds. CO₂ is traditionally considered a non-polar solvent, but there are polarity differences when CO₂ is in its supercritical state versus its liquid state (subcritical or high pressure liquid).



SCIMED™

 Core Separations

CORESEPARATIONS.COM
